

ENGLISH



TABLE OF CONTENTS

14	Introduction	17
15	General	17
15.1	Warranty	17
15.2	Symbols used in this manual	18
16	Device description	18
16.1	Application	18
16.2	Accessories	18
16.3	Safety device	18
17	Safety	19
17.1	Safety instructions	19
18	Mandatory checks before initial use	19
19	Operation / installation manual	20
19.1	Open the door	20
19.2	Mounting on foundation	20
19.3	Insert cable and attach strain relief	22
20	Maintenance	23
21	Transportation and storage	23
22	Resolving problems	23
23	Operation of the charging station	24
24	Technical specifications	25
25	Contact details supplier	27

14. INTRODUCTION

Thank you for choosing an Ecotap® DC charger.

This manual describes the DC charger.

This manual contains important information for the proper and safe installation and operation of the DC charger.

The charging station is designed for vehicles fitted with a mode-4 charging system in line with IEC 61851-1 (edition 2.0) using a connector jack system as per VDE-AR-E 2623-2-2 / IEC 62196-2. Together with the vehicle and system, the charging station will select the best option for charging the vehicle quickly and safely.

The entire charging station complies with EU Directive 2014/35/EU relating to the harmonisation of legislation on electrical equipment within certain voltage limits (re-rating of all versions issued previously).

This manual provides insight into how to install and operate the charging station safely. This manual is drawn up to maximise the function and technical design life of the charging station.

It has been drawn up with the utmost care. However, if there are still any uncertainties, contact your supplier before installing the charging station.

We can only guarantee the functioning of the charging station if the charging station is connected by an authorized or certified fitter/technician.

Read this manual carefully before installing and operating this charging station. Store this manual in the vicinity of the charging station so that the instructions and safety guidelines are always to hand.

© Copyright

No part of this publication may be copied, reproduced or saved in a retrieval system without Ecotap® B.V.'s prior written consent.

This manual is an English translation. The original manual was written in Dutch.







15. GENERAL

15.1 Warranty

The Ecotap® B.V. General Delivery Conditions apply.

Ecotap® B.V. cannot be held responsible for injury or damages as a result of the charging station being changed, damaged, converted, or expanded with other components, or if it is not being used in accordance with the specified instructions and conditions.

15.2 Symbols used in this manual and on the charging system

Symbol	Meaning
	Pay attention! Important instruction
	Electrical hazard
	For maintenance: first disconnect the installation from its power supply and test it to make sure there is no voltage left, before engaging in any maintenance activities
	Wear special gloves.
	Disconnect the electrical installation from its power supply
	Reading this manual is mandatory

16. DEVICE DESCRIPTION

16.1 Application

This charging station is designed for intensive use.

Locations not suitable for installing the charging station:

- All grounds that can flood
- Loading/unloading quay
- Slope at an angle of more than 4%

16.2 Accessories

The following accessories are not included in the scope of delivery:

- Tools

16.3 Safety features

- Lockable using a euro profile cylinder (half)
- Fuse holders / circuit breakers.
- 12/24 Volt control voltage
- Component minimum IP2
- Minimum 3.3 mm steel casing
- IP54.

17. SAFETY

Read the following safety regulations carefully before you install and use the charging station.



17.1 Safety instructions

Before you install the charging station, you must make sure the location is safe for all bystanders. NEVER allow children onto this worksite. Never allow ANYONE who has nothing to do with the work onto the worksite.

- Never be distracted while you are performing the work.
- Make sure you maintain a healthy posture at all times while doing the work.
- Do not leave any tools or charging station components unattended.
- Make sure any tools you are using are clean and dry.
- Make sure that the charging station, tools and components will stay dry when it is raining.

	<p>Make sure that there is no danger of anyone tripping over objects or paving while you are digging the hole for the foundation.</p>
	<p>Make sure to wear good, suitable gloves for any special actions throughout the entire installation and connection process.</p>
	<p>Always check any measuring instruments you will be using to disconnect the installation from its power supply before you use them, checking them several times to make sure they are working properly.</p>

18. MANDATORY CHECKS BEFORE INITIAL USE

	<p>The following checks must be carried out for commissioning of the charging station. NEVER use the charging station if one or more checks indicate that the power supply or stability of the charging station do not meet requirements. Check the insulation resistance between the phases as per NEN1010, provision 61.3.3.</p>
--	--

- ✓ All work described below is in compliance with NEN 3140.
- ✓ Check whether the wires have been connected to the terminals in the right order.
- ✓ Check whether the cores have been properly tightened, see point 19.3
- ✓ Check whether the earth connection is mounted on the connection terminal in accordance with the NEN1010/EU/35 standard.
- ✓ Check whether the cable thickness of the power cable matches the fused current rating.
- ✓ Check whether the charging station is tightly and properly secured.
- ✓ Check whether the station is sufficiently waterproof.
- ✓ Keep the immediate environment of the work area free from obstacles.

Before the power is connected to the charging station, you must first call Ecotap® B.V. on +31 (0)411 745 020 (Mo – Fr 09:00 to 16:00) so that we can activate its software (this requires the unique charging station number).

19. OPERATING / INSTALLATION MANUAL

19.1 Open the door

The door is opened in the following way.

Use a flat-head screwdriver to open the cover plate from the cylinder lock by turning it half a rotation.

Insert the key supplied into the right-hand lock and turn it clockwise until the handle is released. Turn the handle to the right until both the top and bottom of the door are free.

Carry out these steps in reverse to close and lock the door.

19.2 Mounting on the foundation

To fit the foundation, a hole must be dug of roughly L 900 mm x D 450 mm x H 450 mm. The bottom of the hole must be stable and levelled.

Place the foundation base level in the hole. The upper surface of the base must be flush with the upper surface of the grade / paving. The foundation must then be reinforced by adding at least two 20 kg bags of fast-setting concrete in the corners of the foundation.

After the fast-setting concrete has cured, the charging station can be mounted on its foundation using the nuts and bolts provided (nuts to the top).

The hole in the foundation and the charging station must be lined up. See drawing of the front of the foundation base. Take account of the connection face of the charging station in relation to walls, hedges, etc.

Also keep in mind that there is sufficient space for the operation of the charging station. For this we advise to keep at least 1 meter of free space around the charging station.

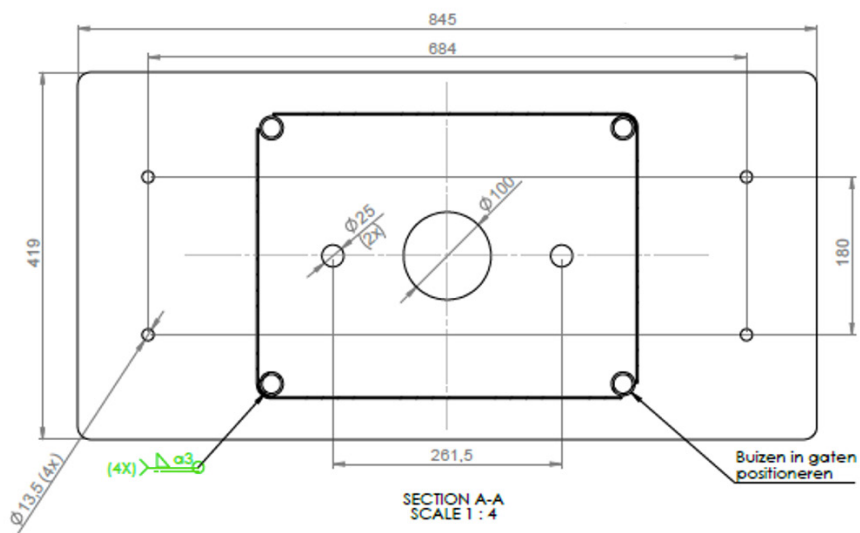

19.3 Inserting cable and securing with strain relief

Secure the power cable in the foundation using the cable gland.

Connect the conductors of the cable to the existing main switch terminals (max. 15 to 22Nm bolt m8 oder 30 to 44Nm bolt n10).

Below is an overview of the wiring diagram

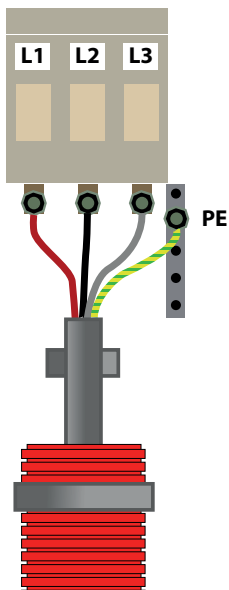

20. MAINTENANCE



Always disconnect the charging station from the power supply and read the manual before performing maintenance or fixing a malfunction.

Only products approved by the supplier can be used to repair or replace components.

Repairs and replacements should always be carried out by a certified specialist.

Maintenance should always comply with and be carried out in accordance with NEN3140 and NEN50110 low voltage EU regulations.

Check the charging station for leaks.

Check the connection of the main power cable and ensure a tight connection, see point 19.3

Treat any damage to the charging station with anti-corrosion paint.

21. TRANSPORTATION AND STORAGE

Transport the charging station (technical core) upright and prevent the paint from being damaged, as this could cause rust.

The covers may be transported in various ways as long as they are protected from damage. Preferably store the charging station in a dry, non-humid space.

When hoisting the charging station into position, there are 2 securing holes for lifting eyes on the top of each corner of the charging station. The lifting eyes can be removed after fitting. To ensure a safe work setting, only a certified fitter may hoist the charging station.

22. RESOLVING PROBLEMS

If the charging station malfunctions, immediately contact the Ecotap® helpdesk, open 24/7 (telephone number: +31 (0)411 745 020) or a certified technician who possesses the necessary measuring and en testing equipment with auto-simulation.

NOTE!

All work on and modifications to the charging station must comply with at least NEN1010.

23. OPERATION AND FUNCTIONING OF THE CHARGING STATION



The charging station is operated using a charging card. This charging card must be registered in the relevant back-office system. This required registration can also be done during office hours by calling Ecotap® B.V. Tel. +31 (0)411 745 020. Once registration is complete, the charging station can be used with any Electric Transport charging card (EV charging card) or other suitable cards, both mobile and tag.

23.1 Operation

Take the plug from the holder of the charging station that is suited to your vehicle. Then insert it in your vehicle. If both CHAdeMO and CCS charging points are available, only one can be used at a time.

Initiate the start/stop procedure by holding your charging card up to the scanning point. Firstly the plug is locked onto the vehicle.

The charging station then communicates with the vehicle and the back-office system. Once all security and payment guidelines have been checked, the maximum permissible charging current is forwarded. After some time, it can occur that the charging station activates the cooling systems fitted for this purpose to dissipate the excess heat via the venting duct. The charging procedure is now activated automatically. The AC charging process is indicated by a small light.

To stop the charging process, hold your card up to the scanning point. The charging process then stops. You can now remove the plug and hang it back up in the available holder.

23.2 Emergency stop

In case of emergency, the emergency stop button must always be used.

This can be reached by pressing (breaking) the glass plate with your thumb.

When activating the emergency stop button, the charging process is disconnected directly, both in terms of software and hardware.

After careful inspection, the back-office system concerned will reset the emergency setting. The emergency stop button will also have to be deactivated on site for this purpose.

24. TECHNICAL SPECIFICATIONS

AC INPUT	
Input voltage:	3f 400VAC \pm 10% + PE
Input frequency:	50Hz
Power factor:	Rated output load PF \geq 0.99
Connection value:	Minimal 3 x 185A (With a lower available capacity, the charger can be set lower by software)
RCD:	Type B
Input under voltage protection:	255V \pm 5V
Input overvoltage protection:	535V \pm 5V
DC OUTPUT	
Protocol:	Mode 4
Output power:	1 - 120 kW CCS
Output voltage range:	200-1000VDC
Output current range:	CCS: 0~250A (400A peak) ,
Output overvoltage protection:	1000 \pm 5V
Output under voltage alarm:	140V \pm 2V
Voltage stabilized accuracy:	\leq \pm 0.5%
Max. startup overshoot:	\leq \pm 1%
Current stabilized accuracy:	\leq \pm 1%
Startup Time:	Normally 3s \leq t \leq 15s
Efficiency:	>96%
OPERATING ENVIRONMENT	
Operating temperature:	-30°C ~ 70°C, derating from 55°C
Overtemperature protection:	On temperature >70°C \pm 4°C or <-40°C \pm 4°C, charger will shut down automatically
Operating/ambient temperature:	-25°- to 60°
Storage temperature:	- 40°C ~ 85°C
Humidity:	\leq 95% RH, without condensation
Pressure/Altitude:	79kPa-106kPa/2000m

PHYSICAL CHARACTERISTICS

Acoustic Noise:	< 51dB (measured at 1 meter distance, under ideal conditions)
Cooling:	Air Cooling fans
Dimensions (HxWxD):	1736 mm x 825 mm x 419 mm
European Standards:	EN 61851-1 2011, EN 6185123-2014, CE
Casing material:	Steel >3 mm
Treatment:	Anti-corrosion and powder coating
Standard colour:	RAL 9016
Weight:	285 kg
Number of charging points:	1 (CCS)
Cable length:	3 meters
MTBF:	> 500000 hrs (40°C)
DC power plug:	Mode 4 (IEC-61851-23/24) Combo-2 (DIN 10121)
Enclosure protection against external impacts:	> IK10 according to IEC 62262

CONTROL

Back office protocol :	OCPP 1.6 Json
Start-Stop:	RFID-card
Suitable charge cards:	Mifare, NTag and iCODE SLI cards (more info)
Network interface:	Ethernet (standard) / GPRS-UMTS (4G)
Push button:	Emergency stop button
Positioning:	GPS

Pay attention ! Earthing (earth dispersion resistance) completely in accordance with the applicable standards.

Ecotap® B.V. reserves the right to change technical details due to continual, innovative development of the charging station, without publishing this in advance. The technical details might also differ from country to country.

25. CONTACT DETAILS SUPPLIER

Ecotap® B.V.
 Kruisbroeksestraat 23
 5281RV Boxtel – The Netherlands
 Tel.: 0031 (0) 411-210210
 E-mail: info@ecotap.nl

26. EU CONFORMITY STATEMENT CE 2022

(Directive 2014/35/EU, Annex II page 96/369, EMC 2014/30/EU)

Ecotap® B.V. Kruisbroeksestraat 23, 5281RV Boxtel, the Netherlands, hereby states that the following charging station meets the requirements of the listed directives and standards.

Type: Ecotap® DC 120

Year of construction: 2022

EU directives used:

- Low-voltage directive 2014/35/EU
- EMC directive 2014/30/EU

Standards used as reference:

- EN 61851-23-2014
- EN 61851-1-2012
- EN 61851-21-2 : 2016
- EN 61000-3-11 2000
- IEC 61000-3-12-2011
- EN 61000-4-2-2009
- EN 61000-4-3-2006
- EN61000-4-4 2012
- EN_61000-4-5-2014
- EN 61000-4-6-2014
- EN 61000-04.08.2010
- EN 61000-4-11-2004
- NEN/EN/IEC 60529
- IEC 62262
- NEN/EN/IEC 61439-1
- IEC/TS 61439-7

Used harmonisation standards:

- NL NEN-EN-IEC 61851-1 / NEN-EN-IEC 61851-22
- FR NF-EN-IEC 61851-1 / NF-EN-IEC 61851-22
- DE DIN-EN 61851-1 / DIN-EN 61851-22
- GB BS-EN 61851-1 :2019 / BS-EN 61851-22
- IT IEC-EN 61851-1 / IEC-EN 61851-22

Boxtel, January 2022



Ir. Ing. P.F.A. van der Putten